















# Fundamental

# Biurka



1	Blaty	<ul style="list-style-type: none"> <li>- z płyty o grubości <b>5,4 cm</b>, oklejonej pvc <b>0,2 cm</b>.</li> <li>- montowane pomiędzy nogami biurek,</li> <li>- połączone z nogami poprzez listwy dystansujące z płyty o grubości <b>1,8 cm</b>,</li> <li>- dostępne z blatem prostokątnym lub zaokrąglonym.</li> </ul>	 <b>Z</b> zaokrąglony blat
2	Przepusty kablowe	<ul style="list-style-type: none"> <li>- o średnicy <b>8 cm</b>,</li> <li>- z tworzywowymi maskownicami: <b>PK5</b> (prostokątnymi) lub <b>PK 4</b> (kwadratowymi)</li> <li>- standardowo - biurka bez przepustów kablowych,</li> <li>- opcjonalnie - umiejscowione wg schematu:</li> </ul>	 <b>PK 4</b> 8 / 8 cm + 75,-   <b>PK 5</b> 30 / 12 cm + 105,-
		 <b>PKL</b> z lewej strony	
		 <b>PKP</b> z prawej strony	
		 <b>PKLP</b> z obu stron	
3	Blendy	<ul style="list-style-type: none"> <li>- z płyty o grubości <b>1,8 cm</b>, oklejonej pvc <b>0,2 cm</b>,</li> <li>- w biurkach z blendą płytową <b>MFB -B</b> są elementem konstrukcyjnym, połączonym z nogami i blatem,</li> <li>- w biurkach <b>MFB</b> z torem kablowym są elementem opcjonalnym, montowanym do spodniej części blatu biurka poprzez metalowe kątowniki,</li> <li>- dostępne w wersjach: płytywnej (<b>MFBL</b>) szklanej (<b>MFBL S</b>),</li> </ul>	 <b>MFBL</b> blenda płytywowa   <b>MFBL S</b> blenda szklana   <b>MFB -B</b> biurka z blendą płytywą
4	Tory kablowe	<ul style="list-style-type: none"> <li>- metalowe, w kształcie litery „L”,</li> <li>- umożliwiają poziome odprowadzenie okablowania,</li> <li>- w biurkach z blendą płytową <b>MFB -B</b> są elementem opcjonalnym, montowanym do blatu</li> <li>- w biurkach <b>MFB</b> są elementem konstrukcyjnym, łączącym blat z nogami,</li> </ul>	 <b>MFTK</b> tor kablowy   <b>MFB</b> biurka z torem kablowym
5	Nogi	<ul style="list-style-type: none"> <li>- z płyty o grubości <b>5,4 cm</b>, oklejonej pvc <b>0,2 cm</b>.</li> <li>- dostępne w wersjach: klasycznej, wyposażone w stopki, poziomujące mebel w zakresie +/- 1 cm, krótkiej, opieranej na komodzie.</li> </ul>	 <b>MFB -851</b> biurka opierane na komodzie
6	Przystawki	<ul style="list-style-type: none"> <li>- z płyty o gr. <b>5,4 cm</b>, oklejonej pvc <b>0,2 cm</b>,</li> <li>- konstrukcyjnie tożsame z biurkami: połączenie blatu z nogą za pomocą dystansu,</li> <li>- w wersjach: lewiej L prawej P</li> </ul>	 <b>L</b> przystawka lewa   <b>P</b> przystawka prawa

# Biurka MFB B | MFB BZ | MFB | MFB Z

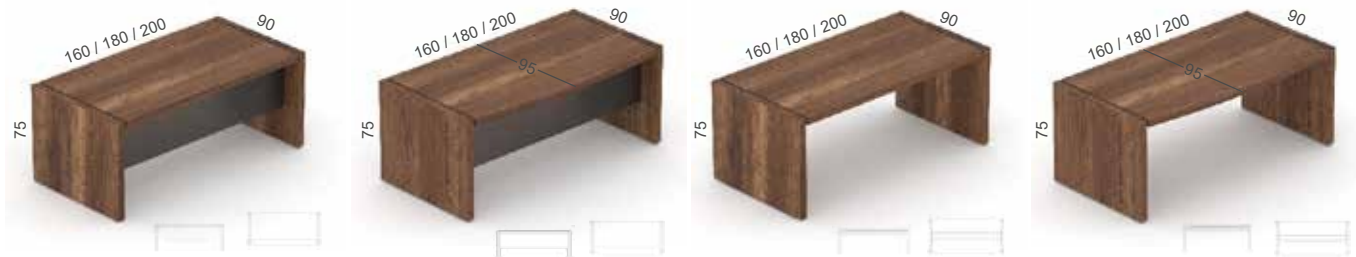

<p><b>MFB 1690 B</b> 160 / 90 / 75 [88]</p> <p>II. 2629,- III. 2892,-</p> <p>opcje MFTK 16 + 157,-</p>	<p><b>MFB 1690 BZ</b> 160 / 90 / 75 [90]</p> <p>II. 2859,- III. 3145,-</p> <p>opcje MFTK 16 + 157,-</p>	<p><b>MFB 1690</b> 160 / 90 / 75 [108]</p> <p>II. 4239,- III. 4663,-</p> <p>opcje MFBL 16 + 355,- MFBSL 16 + 1533,-</p>	<p><b>MFB 1690 Z</b> 160 / 90 / 75 [116]</p> <p>II. 4471,- III. 4918,-</p> <p>opcje MFBL 16 + 355,- MFBSL 16 + 1533,-</p>	<p>diagnoza ok 150 mm</p>
<p><b>MFB 1890 B</b> 180 / 90 / 75 [94]</p> <p>II. 2718,- III. 2990,-</p> <p>opcje MFTK 18 + 187,-</p>	<p><b>MFB 1890 BZ</b> 180 / 90 / 75 [96]</p> <p>II. 2948,- III. 3243,-</p> <p>opcje MFTK 18 + 187,-</p>	<p><b>MFB 1890</b> 180 / 90 / 75 [119]</p> <p>II. 4493,- III. 4942,-</p> <p>opcje MFBL 18 + 375,- MFBSL 18 + 1598,-</p>	<p><b>MFB 1890 Z</b> 180 / 90 / 75 [121]</p> <p>II. 4731,- III. 5204,-</p> <p>opcje MFBL 18 + 375,- MFBSL 18 + 1598,-</p>	<p>diagnoza ok 180 mm</p>
<p><b>MFB 2090 B</b> 200 / 90 / 75 [99]</p> <p>II. 2828,- III. 3111,-</p> <p>opcje MFTK 20 + 187,-</p>	<p><b>MFB 2090 BZ</b> 200 / 90 / 75 [101]</p> <p>II. 3058,- III. 3364,-</p> <p>opcje MFTK 20 + 187,-</p>	<p><b>MFB 2090</b> 200 / 90 / 75 [124]</p> <p>II. 4731,- III. 5204,-</p> <p>opcje MFBL 20 + 395,- MFBSL 20 + 1659,-</p>	<p><b>MFB 2090 Z</b> 200 / 90 / 75 [126]</p> <p>II. 5190,- III. 5709,-</p> <p>opcje MFBL 20 + 395,- MFBSL 20 + 1659,-</p>	<p>diagnoza ok 200 mm</p>



# Biurka MFB | MFB Z

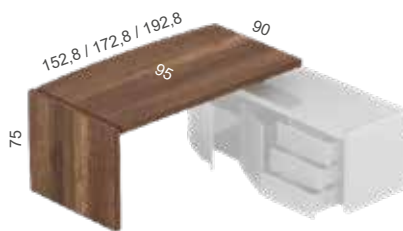

długość ok <b>160</b> cm	<b>MFB 1691</b> 152,8 / 90 / 75 [99]		<b>MFB 1691 Z</b> 152,8 / 90 / 75 [101]	
	opcje <b>MFBL 161 + 305,-</b> <b>MFBSL 161 + 1259,-</b>		opcje <b>MFBL 161 + 305,-</b> <b>MFBSL 161 + 1259,-</b>	
długość ok <b>180</b> cm	<b>MFB 1891</b> 172,8 / 90 / 75 [104]		<b>MFB 1891 Z</b> 172,8 / 90 / 75 [106]	
	opcje <b>MFBL 181 + 333,-</b> <b>MFBSL 181 + 1369,-</b>		opcje <b>MFBL 181 + 333,-</b> <b>MFBSL 181 + 1369,-</b>	
długość ok <b>200</b> cm	<b>MFB 2091</b> 192,8 / 90 / 75 [109]		<b>MFB 2091 Z</b> 192,8 / 90 / 75 [111]	
	opcje <b>MFBL 201 + 355,-</b> <b>MFBSL 181 + 1533,-</b>		opcje <b>MFBL 181 + 355,-</b> <b>MFBSL 181 + 1533,-</b>	

produkty powiązane :



**27**  
komody



**17**  
biurka z komodami

## Przystawki MFP

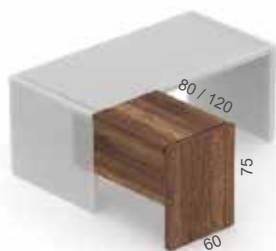

<p><b>MFP 81 L/P</b> 80 / 60 / 75 [40]</p> <p>II. 1671,- III. 1838,-</p>	 <p>dlugość: <b>80</b> cm</p>
<p><b>MFP 121 L/P</b> 120 / 60 / 75 [46]</p> <p>II. 1808,- III. 1989,-</p>	 <p>dlugość: <b>120</b> cm</p>

produkty powiązane



**25**  
biurka



**29**  
kontenerki



**29**  
komody



**31**  
stoły



**33**  
szafy



**37**  
zestawy

# Komody i kontenerki

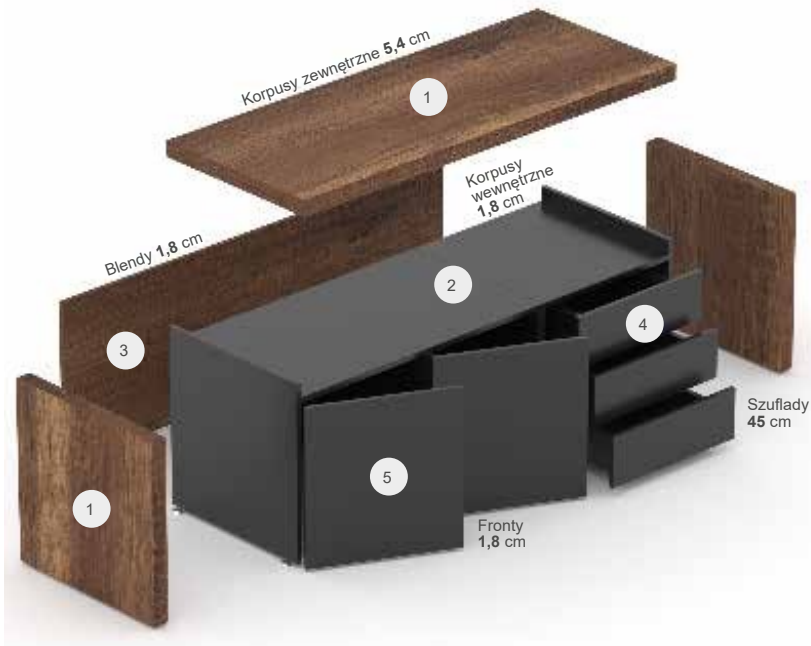

<p>1 Korpusty zewnętrzne</p>	<ul style="list-style-type: none"> <li>- z płyty o gr. 5,4 cm, oklejonej pvc 0,2 cm,</li> <li>- otaczają korpusty zewnętrzne z boków i z góry.</li> <li>- okładziny górne wpuszczane,</li> <li>- połączone z bokami za pośrednictwem dystansów z płyty o grubości 1,8 cm,</li> </ul>	 <p><b>EXKB 160/161</b> komody boczne</p>  <p><b>EXKB 60/61</b> komody frontowe</p>
<p>2 Korpusty wewnętrzne</p>	<ul style="list-style-type: none"> <li>- z płyty o gr. 1,8 cm, oklejonej pvc 0,2 cm,</li> <li>- połączone w niewidoczny sposób za pomocą złącz mimośrodowych,</li> <li>- dostępne w wersjach: z frontem uchylnym lub z szufladami.</li> <li>- kontenerki mobilne - wyposażone w <b>tworzywowe kółka</b> (2 przednie z hamulcem)</li> <li>- komody biurkowe - wyposażone w <b>chromowane stopki poziomujące</b> w zakresie + / - 1 cm</li> <li>- korpusty komód biurowych mogą być zorientowane w stronę siedzącego lub na zewnątrz:</li> </ul>	 <p>orientacja 1-stronna</p>  <p>orientacja 2-stronna</p>
<p>3 Blendy</p>	<ul style="list-style-type: none"> <li>- z płyty o grubości 1,8 cm, oklejonej pvc 0,2 cm,</li> <li>- łączą korpusty zewnętrzne komód,</li> </ul>	
<p>4 Szuflady</p>	<ul style="list-style-type: none"> <li>- z płyty o gr. 1,8 cm, oklejonej pvc 0,2 cm</li> <li>- z mechanizmem cichego domyku,</li> <li>- z pełnym wysuwem,</li> <li>- z samodociąganiem,</li> <li>- opcjonalnie: z uchwytem chromowanym <b>U2</b>, o rozstawie <b>19,2 cm</b></li> <li>z uchwytnymi, zamykanymi zamkiem <b>U2Z</b> centralnym (szuflady) lub punktowym (fronty skrzydowe).</li> </ul>	 <p><b>U2</b> uchwyty 19,2 cm + 40,- / szt</p>  <p><b>Z</b> zamek + 100,- / szt</p>
<p>5 Fronty</p>	<ul style="list-style-type: none"> <li>- z płyty o grubości 1,8 cm, oklejonej pvc 0,2 cm,</li> <li>- dostępne w wersji szufladowej oraz uchylnej,</li> <li>- fronty uchylne z zawiasami o kącie otwarcia <b>110°</b>,</li> <li>- standardowo bez zamków,</li> <li>- otwierane systemem push to open,</li> <li>- opcjonalnie wykonane ze szkła.</li> </ul>	<p><b>FS K1</b> fronty chylne szklane</p> <p><b>FS K2</b> fronty szuflad szklane</p>

## Komody MFKB



### MFKB 171

164,4 / 60 / 60 [173]

II. 4212,-  
III. 4633,-



opcje

5x U2. + 200,-  
3x Z. + 300,-

FSK 1 + 1860,-  
FSK 2 + 783,-

### MFKB 68

59 / 80 / 60 [95]

II. 2435,-  
III. 2679,-



opcje

3x U2. + 120,-  
Z. + 100,-

FSK 2 + 783,-

## Kontenerki MFKP

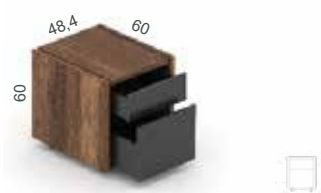

### MFKP 12

48,4 / 60 / 60 [59]

II. 2128,-  
III. 2341,-



opcje

2x U2. + 80,-  
Z. + 100,-

FSK 2. + 783,-

### MFKP 13

48,4 / 60 / 60 [61]

II. 2328,-  
III. 2561,-



opcje

3x U2. + 120,-  
Z. + 100,-

FSK 2 + 783,-

produkty powiązane



25 biurka



27 przystawki



31 stoły



33 szafy



37 zestawy

# Stoły



<p>1 Blaty</p>	<ul style="list-style-type: none"> <li>- z płyty o grubości <b>5,4 cm</b>, oklejonej pvc <b>0,2 cm</b>,</li> <li>- w stołach wielomodułowych, każdy z elementów stołu z osobnym blatem,</li> <li>- dostępne w formie prostokątnej oraz zaokrąglonej <b>Z</b>,</li> </ul> <p>opcjonalnie:</p> <ul style="list-style-type: none"> <li>- z przełotem kablowym,</li> <li>- z mediaportem,</li> </ul>	 <p><b>PK 6</b> 27,6 x 12 cm + 262,- / szt</p>
<p>2 Blendy</p>	<ul style="list-style-type: none"> <li>- z płyty o grubości <b>1,8 cm</b>, oklejonej pvc <b>0,2 cm</b>,</li> <li>- są elementem konstrukcyjnym stołu.</li> </ul>	
<p>3 Nogi</p>	<ul style="list-style-type: none"> <li>- z płyty o grubości <b>5,4 cm</b>, oklejonej pvc <b>0,2 cm</b>,</li> <li>- wyposażone w stopki poziomujące w zakresie <b>+ /- 1 cm</b>.</li> </ul>	

# Stoły MFSK | MFST



**MFSK 180**  
180 / 120 / 75 [128]

II. 2889,-  
III. 3178,-

**MFSK 240**  
240 / 140 / 75 [157]

II. 3169,-  
III. 3486,-

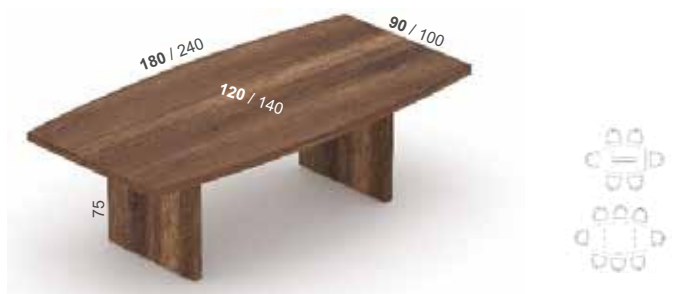

**MFSK 180 Z**  
180 / 120 / 75 [122]

II. 2989,-  
III. 3288,-

**MFSK 240 Z**  
240 / 140 / 75 [153]

II. 3269,-  
III. 3596,-

dlugosc  
**180** cm

dlugosc  
**240** cm



**MFSK 320**  
320 / 140 / 75 [150]

II. 4631,-  
III. 5094,-

**MFSK 400**  
400 / 140 / 75 [155]

II. 5115,-  
III. 5626,-



**MFSK 320 Z**  
320 / 140 / 75 [167]

II. 4895,-  
III. 5385,-

**MFSK 400 Z**  
400 / 140 / 75 [187]

II. 5828,-  
III. 6411,-

dlugosc  
**320** cm

dlugosc  
**400** cm



**MFST 80**  
80 / 80 / 60 [73]

II. 1576,-  
III. 1734,-

**MFST 80 W**  
80 / 80 / 75 [81]

II. 1864,-  
III. 2050,-



**MFST 80 Z**  
80 / 80 / 60 [72]

II. 1715,-  
III. 1886,-

**MFST 80 WZ**  
80 / 80 / 75 [80]

II. 2152,-  
III. 2367,-

# Szafy









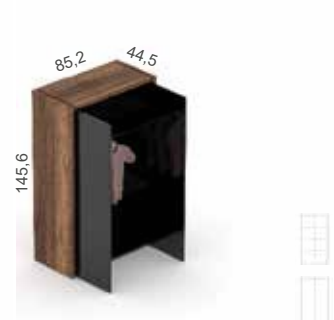
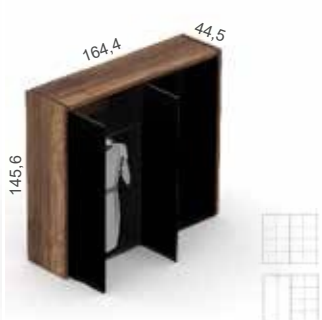

1	<b>Korpusy zewnętrzne</b>	<ul style="list-style-type: none"> <li>- z płyty o grubości <b>1,8 cm</b> (z tyłu) oraz <b>2,8 cm</b> (z boków i z góry), oklejonej pvc <b>0,2 cm</b>,</li> <li>- otaczają korpus wewnętrzny,</li> <li>- pełnią funkcję wieńca górnego i bocznych okładzin,</li> <li>- połączone z bokami za pośrednictwem dystansów z płyty o grubości <b>1,8 cm</b>,</li> <li>- są integralną częścią mebla,</li> </ul>	
2	<b>Korpusy wewnętrzne</b>	<ul style="list-style-type: none"> <li>- z płyty o grubości <b>1,8 cm</b>, oklejonej pvc <b>0,2 cm</b>,</li> <li>- połączone w niewidoczny sposób złączami mimośrodowymi,</li> <li>- wieńce dolne wyposażone w stopki poziomujące, tworzywowe, z zakresem regulacji <b>+ /- 1 cm</b>,</li> <li>- półki zabezpieczone przed przypadkowym wysuwaniem,</li> <li>- w wersjach:               <ul style="list-style-type: none"> <li>aktowej (z półkami)</li> <li>ubraniowej (z 1 półką oraz z drążkiem ubraniowym)</li> </ul> </li> </ul>	 <b>U</b> szafa ubraniowa   <b>UA</b> szafy ubraniowo aktowa
3	<b>Fronty</b>	<ul style="list-style-type: none"> <li>- z płyty o grubości <b>1,8 cm</b>, oklejonej pvc <b>0,2 cm</b>,</li> <li>- z zawiasami metalowymi o kącie <b>110 °</b></li> <li>- bezuchwytowe, otwierane systemem push to open</li> <li>- opcjonalnie;               <ul style="list-style-type: none"> <li>z uchwytem chromowanym <b>U2</b>, o <b>rozstawie 19,2 cm</b>,</li> <li>z uchwytnymi, zamykane zamkiem baskwilowym <b>ZB</b>.</li> </ul> </li> </ul>	 <b>ZB</b> zamek baskwilowy + 153,- /kpl   <b>U2</b> uchwyty 19,2 cm + 40,- / szt
4	<b>Fronty szklane</b>	<ul style="list-style-type: none"> <li>- ze szkła hartowanego lub iacobel o gr. <b>0,4 cm</b>,</li> <li>- fronty FSAL ze szkła otoczonego aluminiowymi ramkami,</li> <li>- standardowo bez zamka,</li> </ul>	 <b>FSAL</b> fronty szklane w ramie aluminiowej







## Szafy 4-oh MF | MF U | MF UA



aktywne	aktywne - "darmowe"
<b>MF 4204</b> 204,4 / 44,5 / 145,6 [287] 	<b>MF 4164</b> 164,4 / 44,5 / 145,6 [242] 
<b>MF 4204 UA</b> 204,4 / 44,5 / 145,6 [287] 	<b>MF 4164 UA</b> 164,4 / 44,5 / 145,6 [242] 
<b>II. 6634,-</b> <b>III. 7297,-</b>	<b>II. 6021,-</b> <b>III. 6623,-</b>
opcje 4x U2 + 160,-      2x FSAL 4 + 2230- 2x ZB + 306,-	opcje 4x U2 + 160,-      2x FSAL 4 + 2230- 2x ZB + 306,-
<b>MF 41641</b> 164,4 / 44,5 / 145,6 [215] 	<b>MF 484</b> 85,2 / 44,5 / 145,6 [135] 
<b>MF 41641 UA</b> 164,4 / 44,5 / 145,6 [215] 	<b>MF 484 U</b> 85,2 / 44,5 / 145,6 [135] 
<b>II. 5349,-</b> <b>III. 5883,-</b>	<b>II. 3151,-</b> <b>III. 3466,-</b>
opcje 2x U2 + 80,-      2x FSAL 46 + 2108- 2x ZB + 306,-	opcje 2x U2 + 80,-      FSAL 4 + 1115- ZB + 153,-

## Szafy 3-oh MF



<b>MF 3203</b> 204,4 / 44,5 / 110,4 [185] 	<b>MF 3163</b> 164,4 / 44,5 / 110,4 [152] 
<b>II. 5273,-</b> <b>III. 5801,-</b>	<b>II. 4489,-</b> <b>III. 4937,-</b>
opcje 4x U2 + 160,-      2x FSAL 3 + 1770- 2x ZB + 306,-	opcje 4x U2 + 160,-      2x FSAL 3 + 1770- 2x ZB + 306,-
<b>MF 31631</b> 164,4 / 44,5 / 110,4 [157] 	<b>MF 383</b> 85,2 / 44,5 / 110,4 [87] 
<b>II. 4832,-</b> <b>III. 5315,-</b>	<b>II. 2934,-</b> <b>III. 3228,-</b>
opcje 2x U2 + 80,-      2x FSAL 36 + 1550- 2x ZB + 306,-	opcje 2x U2 + 80,-      FSAL 3 + 885- ZB + 153,-

## Szafy 2-oh MF

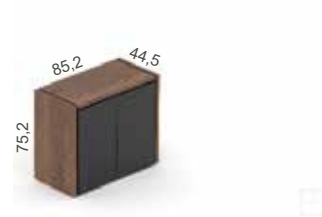

**MF 2202**  
204,4 / 44,5 / 75,2 [135]

II. 4706,-  
III. 5176,-

opcje

4x U2	+ 160,-	2x FSAL 2	+ 1324,-
2x ZB	+ 306,-		

**MF 2162**  
164,4 / 44,5 / 75,2 [110]

II. 4168,-  
III. 4585,-

opcje

4x U2	+ 160,-	2x FSAL 2	+ 1324,-
2x ZB	+ 306,-		

**MF 21621**  
164,4 / 44,5 / 75,2 [96]

II. 3263,-  
III. 3590,-

opcje

2x U2	+ 80,-	2x FSAL 26	+ 908,-
2x ZB	+ 306,-		

**MF 282**  
85,2 / 44,5 / 75,2 [62]

II. 2322,-  
III. 2554,-

opcje

2x U2	+ 80,-	FSAL 2	+ 662,-
ZB	+ 153,-		

produkty powiązane



**25**  
biurka



**27**  
przystawki



**29**  
kontenerki



**29**  
komody



**31**  
stoły



**37**  
zestawy

M

# Fundamental

Zestawy

## Biorka z komodami

MFB + MFKB



Model	Wymiary (cm)	Cena II	Cena III	Opcje
<b>MF Z1</b> MFB 1691 MFKB 171	152,8 / 164,4 / 75 [272]	<b>II. 7267,-</b>	<b>III. 7993,-</b>	opcje <b>MFBL 16 + 355,-</b> <b>MFBSL 16 + 1533,-</b> 5x U2. + 200,- 3x Z + 300,- FSK 1 + 1860,- FSK 2 + 783,-
<b>MF Z1 Z</b> MFB 1691 Z MFKB 171	152,8 / 164,4 / 75 [274]	<b>II. 7562,-</b>	<b>III. 8318,-</b>	opcje <b>MFBL 16 + 355,-</b> <b>MFBSL 16 + 1533,-</b> 5x U2. + 200,- 3x Z + 300,- FSK 1 + 1860,- FSK 2 + 783,-
<b>MF Z4</b> MFB 1691 MFKB 68	152,8 / 90 / 75 [194]	<b>II. 5490,-</b>	<b>III. 6039,-</b>	opcje <b>MFBL 16 + 355,-</b> <b>MFBSL 16 + 1533,-</b> 3x U2. + 120,- Z + 100,- FSK 2 + 783,-
<b>MF Z4 Z</b> MFB 1691 Z MFKB 68	152,8 / 90 / 75 [196]	<b>II. 5785,-</b>	<b>III. 6364,-</b>	opcje <b>MFBL 16 + 355,-</b> <b>MFBSL 16 + 1533,-</b> 3x U2. + 120,- Z + 100,- FSK 2 + 783,-
<b>MF Z2</b> MFB 1891 MFKB 171	172,8 / 164,4 / 75 [277]	<b>II. 7390,-</b>	<b>III. 8129,-</b>	opcje <b>MFBL 18 + 375,-</b> <b>MFBSL 18 + 1598,-</b> 5x U2. + 200,- 3x Z + 300,- FSK 1 + 1860,- FSK 2 + 783,-
<b>MF Z2 Z</b> MFB 1891 Z MFKB 171	172,8 / 164,4 / 75 [279]	<b>II. 7682,-</b>	<b>III. 8450,-</b>	opcje <b>MFBL 18 + 375,-</b> <b>MFBSL 18 + 1598,-</b> 5x U2. + 200,- 3x Z + 300,- FSK 1 + 1860,- FSK 2 + 783,-
<b>MF Z5</b> MFB 1891 MFKB 68	172,8 / 90 / 75 [199]	<b>II. 5613,-</b>	<b>III. 6174,-</b>	opcje <b>MFBL 18 + 375,-</b> <b>MFBSL 18 + 1598,-</b> 3x U2. + 120,- Z + 100,- FSK 2 + 783,-
<b>MF Z5 Z</b> MFB 1891 Z MFKB 68	172,8 / 90 / 75 [201]	<b>II. 5905,-</b>	<b>III. 6496,-</b>	opcje <b>MFBL 18 + 375,-</b> <b>MFBSL 18 + 1598,-</b> 3x U2. + 120,- Z + 100,- FSK 2 + 783,-
<b>MF Z3</b> MFB 2091 MFKB 171	192,8 / 164,4 / 75 [282]	<b>II. 7732,-</b>	<b>III. 8505,-</b>	opcje <b>MFBL 20 + 395,-</b> <b>MFBSL 20 + 1659,-</b> 5x U2. + 200,- 3x Z + 300,- FSK 1 + 1860,- FSK 2 + 783,-
<b>MF Z3 Z</b> MFB 2091 Z MFKB 171	192,8 / 164,4 / 75 [284]	<b>II. 8032,-</b>	<b>III. 8835,-</b>	opcje <b>MFBL 20 + 395,-</b> <b>MFBSL 20 + 1659,-</b> 5x U2. + 200,- 3x Z + 300,- FSK 1 + 1860,- FSK 2 + 783,-
<b>MF Z6</b> MFB 2091 MFKB 68	192,8 / 90 / 75 [204]	<b>II. 5955,-</b>	<b>III. 6551,-</b>	opcje <b>MFBL 20 + 395,-</b> <b>MFBSL 20 + 1659,-</b> 3x U2. + 120,- Z + 100,- FSK 2 + 783,-
<b>MF Z6 Z</b> MFB 2091 Z MFKB 68	192,8 / 90 / 75 [206]	<b>II. 6255,-</b>	<b>III. 6881,-</b>	opcje <b>MFBL 20 + 395,-</b> <b>MFBSL 20 + 1659,-</b> 3x U2. + 120,- Z + 100,- FSK 2 + 783,-
blaty prostokątne		blaty zaokrąglone <b>Z</b>		
blaty prostokątne		blaty zaokrąglone <b>Z</b>		

# Biurka z kontenerkami

## MFB + MFKP

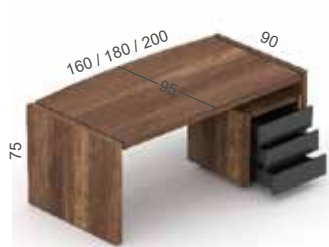
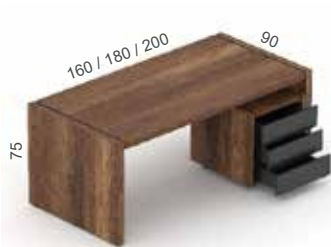

MFB Z7 B		MFB Z7		MFB Z7 BZ		MFB Z7 Z		diagr. ok 160cm
MFB 1690 B MFKP 13		MFB 1690 MFKP 13		MFB 1690 BZ MFKP 13		MFB 1690 Z MFKP 13		
160 / 90 / 75 [149]		160 / 90 / 75 [169]		160 / 90 / 75 [151]		160 / 90 / 75 [177]		
II. 4957,- III. 5453,-		II. 6567,- III. 7224,-		II. 5187,- III. 5706,-		II. 6799,- III. 7479,-		
opcje		opcje		opcje		opcje		
MFTK 16 + 157,-	3x U2. + 120,- Z + 100,- FSK 2 + 783,-	MFBL 16 + 355,- MFBSL 16 + 1533,-	3x U2. + 120,- Z + 100,- FSK 2 + 783,-	MFTK 16 + 157,-	3x U2. + 120,- Z + 100,- FSK 2 + 783,-	MFBL 16 + 355,- MFBSL 16 + 1533,-	3x U2. + 120,- Z + 100,- FSK 2 + 783,-	
MFB Z8 B		MFB Z8		MFB Z8 BZ		MFB Z8 Z		diagr. ok 180cm
MFB 1890 B MFKP 13		MFB 1890 MFKP 13		MFB 1890 BZ MFKP 13		MFB 1890 Z MFKP 13		
180 / 90 / 75 [155]		180 / 90 / 75 [180]		180 / 90 / 75 [157]		180 / 90 / 75 [182]		
II. 5046,- III. 5551,-		II. 6821,- III. 7503,-		II. 5276,- III. 5804,-		II. 7059,- III. 7764,-		
opcje		opcje		opcje		opcje		
MFTK 18 + 173,-	3x U2. + 120,- Z + 100,- FSK 2 + 783,-	MFBL 18 + 375,- MFBSL 18 + 1598,-	3x U2. + 120,- Z + 100,- FSK 2 + 783,-	MFTK 18 + 173,-	3x U2. + 120,- Z + 100,- FSK 2 + 783,-	MFBL 18 + 375,- MFBSL 18 + 1598,-	3x U2. + 120,- Z + 100,- FSK 2 + 783,-	
MFB Z9 B		MFB Z9		MFB Z9 BZ		MFB Z9 Z		diagr. ok 200cm
MFB 2090 B MFKP 13		MFB 2090 MFKP 13		MFB 2090 BZ MFKP 13		MFB 2090 Z MFKP 13		
200 / 90 / 75 [160]		200 / 90 / 75 [185]		200 / 90 / 75 [162]		200 / 90 / 75 [187]		
II. 5156,- III. 5672,-		II. 7059,- III. 7764,-		II. 5386,- III. 5925,-		II. 7518,- III. 8270,-		
opcje		opcje		opcje		opcje		
MFTK 20 + 187,-	3x U2. + 120,- Z + 100,- FSK 2 + 783,-	MFBL 20 + 395,- MFBSL 20 + 1659,-	3x U2. + 120,- Z + 100,- FSK 2 + 783,-	MFTK 20 + 187,-	3x U2. + 120,- Z + 100,- FSK 2 + 783,-	MFBL 20 + 395,- MFBSL 20 + 1659,-	3x U2. + 120,- Z + 100,- FSK 2 + 783,-	
blaty prostokątne		blaty prostokątne		blaty zaokrąglone Z		blaty zaokrąglone Z		

produkty powiązane



25 biurka



27 przystawki



29 kontenerki



29 komody



31 stoły



33 szafy

## Biorka z przystawkami

MFB + MFKB



długość biurka 160 cm / przystawki 80 cm	<b>MFB Z10 B</b> MFB 1690 B MFKP 13 MFP 81 160 / 170 / 75 [189] <b>II. 6628,-</b> <b>III. 7291,-</b>		<b>MFB Z10</b> MFB 1690 MFKP 13 MFP 81 160 / 170 / 75 [209] <b>II. 8238,-</b> <b>III. 9062,-</b>		<b>MFB Z10 BZ</b> MFB 1690 BZ MFKP 13 MFP 81 160 / 170 / 75 [191] <b>II. 6858,-</b> <b>III. 7544,-</b>		<b>MFB Z10 Z</b> MFB 1690 Z MFKP 13 MFP 81 160 / 170 / 75 [217] <b>II. 8470,-</b> <b>III. 9317,-</b>	
	opcje		opcje		opcje		opcje	
	MFTK 16 + 157,-	3x U2. + 285,- Z. + 100,- FSK 2 + 783,-	MFBL 16 + 355,- MFBSL 16 + 1533,-	3x U2. + 285,- Z. + 100,- FSK 2 + 783,-	MFTK 16 + 157,-	3x U2. + 285,- Z. + 100,- FSK 2 + 783,-	MFBL 16 + 355,- MFBSL 16 + 1533,-	3x U2. + 285,- Z. + 100,- FSK 2 + 783,-
	blaty prostokątne		blaty prostokątne		blaty zaokrąglone <b>Z</b>		blaty zaokrąglone <b>Z</b>	
długość biurka 180 cm / przystawki 80 cm	<b>MFB Z11 B</b> MFB 1890 B MFKP 13 MFP 81 180 / 170 / 75 [195] <b>II. 6717,-</b> <b>III. 7389,-</b>		<b>MFB Z11</b> MFB 1890 MFKP 13 MFP 81 180 / 170 / 75 [220] <b>II. 8492,-</b> <b>III. 9341,-</b>		<b>MFB Z11 BZ</b> MFB 1890 BZ MFKP 13 MFP 81 180 / 170 / 75 [197] <b>II. 6947,-</b> <b>III. 7642,-</b>		<b>MFB Z11 Z</b> MFB 1890 Z MFKP 13 MFP 81 180 / 170 / 75 [222] <b>II. 8730,-</b> <b>III. 9603,-</b>	
	opcje		opcje		opcje		opcje	
	MFTK 18 + 173,-	3x U2. + 285,- Z. + 100,- FSK 2 + 783,-	MFBL 18 + 375,- MFBSL 18 + 1598,-	3x U2. + 285,- Z. + 100,- FSK 2 + 783,-	MFTK 18 + 173,-	3x U2. + 285,- Z. + 100,- FSK 2 + 783,-	MFBL 18 + 375,- MFBSL 18 + 1598,-	3x U2. + 285,- Z. + 100,- FSK 2 + 783,-
	blaty prostokątne		blaty prostokątne		blaty zaokrąglone <b>Z</b>		blaty zaokrąglone <b>Z</b>	
długość biurka 200 cm / przystawki 120 cm	<b>MFB Z12 B</b> MFB 2090 B MFKP 13 MFP 121 200 / 210 / 75 [206] <b>II. 6964,-</b> <b>III. 7661,-</b>		<b>MFB Z12</b> MFB 2090 MFKP 13 MFP 121 200 / 210 / 75 [231] <b>II. 8867,-</b> <b>III. 9754,-</b>		<b>MFB Z12 BZ</b> MFB 2090 BZ MFKP 13 MFP 121 200 / 210 / 75 [208] <b>II. 7194,-</b> <b>III. 7914,-</b>		<b>MFB Z12 Z</b> MFB 2090 Z MFKP 13 MFP 121 200 / 210 / 75 [233] <b>II. 9326,-</b> <b>III. 10259,-</b>	
	opcje		opcje		opcje		opcje	
	MFTK 20 + 187,-	3x U2. + 285,- Z. + 100,- FSK 2 + 783,-	MFBL 20 + 395,- MFBSL 20 + 1659,-	3x U2. + 285,- Z. + 100,- FSK 2 + 783,-	MFTK 20 + 187,-	3x U2. + 285,- Z. + 100,- FSK 2 + 783,-	MFBL 20 + 395,- MFBSL 20 + 1659,-	3x U2. + 285,- Z. + 100,- FSK 2 + 783,-
	blaty prostokątne		blaty prostokątne		blaty zaokrąglone <b>Z</b>		blaty zaokrąglone <b>Z</b>	



dl. / gł. / wys. cm



[waga] kg



gr. cenowe: II. druga III. trzecia + dopłata

M

produkty powiązane



**25**  
biurka



**27**  
przystawki



**29**  
kontenerki



**29**  
komody



**31**  
stoły



**33**  
szafy

Wszystkie ceny podane w cenniku są cenami netto. Ceny nie zawierają kosztów dostawy i montażu. Massoni zastrzega sobie prawo do wprowadzania zmian w oferowanych meblach. Cennik przeznaczony jest tylko do użytku adresata, zawiera poufne i prawnie zastrzeżone informacje. Rozpowszechnianie, udostępnianie lub kopiowanie bez zgody nadawcy stanowi naruszenie tajemnicy handlowej w rozumieniu określonym przez Kodeks Cywilny.

## Biuorka z kontenerkami i z szafami

MFB + MFKP + MF



długość 160,0m	<b>MF Z13 B</b> MFB 1690 B MFKP 13 MF 2162 160 / 90 / 75 [259] <b>II. 9125,-</b> <b>III. 10038,-</b>		<b>MF Z13</b> MFB 1690 MFKP 13 MF 2162 160 / 90 / 75 [279] <b>II. 10735,-</b> <b>III. 11809,-</b>		<b>MF Z16 BZ</b> MFB 1690 BZ MFKP 13 MF 31631 160 / 90 / 75 [306] <b>II. 10019,-</b> <b>III. 11021,-</b>		<b>MF Z16 Z</b> MFB 1690 Z MFKP 13 MF 31631 160 / 90 / 75 [308] <b>II. 11631,-</b> <b>III. 12794,-</b>	
	opcje <b>MFTK 16</b> + 157,- <b>4x u2.</b> + 160,- <b>2x ZB.</b> + 306,- <b>3x u2.</b> + 120,- <b>2x FSAL 2</b> + 1324,- <b>Z.</b> + 100,- <b>FSK 2.</b> + 783,-		opcje <b>MFBL 16</b> + 355,- <b>4x u2.</b> + 160,- <b>2x ZB.</b> + 306,- <b>3x u2.</b> + 120,- <b>2x FSAL 2</b> + 1324,- <b>Z.</b> + 100,- <b>FSK 2.</b> + 783,-		opcje <b>MFTK 16</b> + 157,- <b>2x u2.</b> + 80,- <b>2x ZB.</b> + 306,- <b>3x u2.</b> + 120,- <b>2x FSAL 36</b> + 1550,- <b>Z.</b> + 100,- <b>FSK 2.</b> + 783,-		opcje <b>MFBL 16</b> + 355,- <b>2x u2.</b> + 80,- <b>2x ZB.</b> + 306,- <b>3x u2.</b> + 120,- <b>2x FSAL 36</b> + 1550,- <b>Z.</b> + 100,- <b>FSK 2.</b> + 783,-	
	opcje <b>MFTK 18</b> + 173,- <b>4x u2.</b> + 160,- <b>2x ZB.</b> + 306,- <b>3x u2.</b> + 120,- <b>2x FSAL 2</b> + 1324,- <b>Z.</b> + 100,- <b>FSK 2.</b> + 783,-		opcje <b>MFBL 18</b> + 375,- <b>4x u2.</b> + 160,- <b>2x ZB.</b> + 306,- <b>3x u2.</b> + 120,- <b>2x FSAL 2</b> + 1324,- <b>Z.</b> + 100,- <b>FSK 2.</b> + 783,-		opcje <b>MFTK 18</b> + 173,- <b>2x u2.</b> + 80,- <b>2x ZB.</b> + 306,- <b>3x u2.</b> + 120,- <b>2x FSAL 36</b> + 1550,- <b>Z.</b> + 100,- <b>FSK 2.</b> + 783,-		opcje <b>MFBL 18</b> + 375,- <b>2x u2.</b> + 80,- <b>2x ZB.</b> + 306,- <b>3x u2.</b> + 120,- <b>2x FSAL 36</b> + 1550,- <b>Z.</b> + 100,- <b>FSK 2.</b> + 783,-	
	opcje <b>MFTK 20</b> + 187,- <b>4x u2.</b> + 160,- <b>2x ZB.</b> + 306,- <b>3x u2.</b> + 120,- <b>2x FSAL 2</b> + 1324,- <b>Z.</b> + 100,- <b>FSK 2.</b> + 783,-		opcje <b>MFBL 20</b> + 395,- <b>4x u2.</b> + 160,- <b>2x ZB.</b> + 306,- <b>3x u2.</b> + 120,- <b>2x FSAL 2</b> + 1324,- <b>Z.</b> + 100,- <b>FSK 2.</b> + 783,-		opcje <b>MFTK 20</b> + 187,- <b>2x u2.</b> + 80,- <b>2x ZB.</b> + 306,- <b>3x u2.</b> + 120,- <b>2x FSAL 36</b> + 1550,- <b>Z.</b> + 100,- <b>FSK 2.</b> + 783,-		opcje <b>MFBL 20</b> + 395,- <b>2x u2.</b> + 80,- <b>2x ZB.</b> + 306,- <b>3x u2.</b> + 120,- <b>2x FSAL 36</b> + 1550,- <b>Z.</b> + 100,- <b>FSK 2.</b> + 783,-	
długość 180,0m	<b>MF Z14 B</b> MFB 1890 B MFKP 13 MF 2162 180 / 90 / 75 [265] <b>II. 9214,-</b> <b>III. 10136,-</b>		<b>MF Z14</b> MFB 1890 MFKP 13 MF 2162 180 / 90 / 75 [290] <b>II. 10989,-</b> <b>III. 12088,-</b>		<b>MF Z17 BZ</b> MFB 1890 BZ MFKP 13 MF 31631 180 / 90 / 75 [312] <b>II. 10108,-</b> <b>III. 11119,-</b>		<b>MF Z17 Z</b> MFB 1890 Z MFKP 13 MF 31631 180 / 90 / 75 [314] <b>II. 11891,-</b> <b>III. 13080,-</b>	
	opcje <b>MFTK 18</b> + 173,- <b>4x u2.</b> + 160,- <b>2x ZB.</b> + 306,- <b>3x u2.</b> + 120,- <b>2x FSAL 2</b> + 1324,- <b>Z.</b> + 100,- <b>FSK 2.</b> + 783,-		opcje <b>MFBL 18</b> + 375,- <b>4x u2.</b> + 160,- <b>2x ZB.</b> + 306,- <b>3x u2.</b> + 120,- <b>2x FSAL 2</b> + 1324,- <b>Z.</b> + 100,- <b>FSK 2.</b> + 783,-		opcje <b>MFTK 18</b> + 173,- <b>2x u2.</b> + 80,- <b>2x ZB.</b> + 306,- <b>3x u2.</b> + 120,- <b>2x FSAL 36</b> + 1550,- <b>Z.</b> + 100,- <b>FSK 2.</b> + 783,-		opcje <b>MFBL 18</b> + 375,- <b>2x u2.</b> + 80,- <b>2x ZB.</b> + 306,- <b>3x u2.</b> + 120,- <b>2x FSAL 36</b> + 1550,- <b>Z.</b> + 100,- <b>FSK 2.</b> + 783,-	
	opcje <b>MFTK 20</b> + 187,- <b>4x u2.</b> + 160,- <b>2x ZB.</b> + 306,- <b>3x u2.</b> + 120,- <b>2x FSAL 2</b> + 1324,- <b>Z.</b> + 100,- <b>FSK 2.</b> + 783,-		opcje <b>MFBL 20</b> + 395,- <b>4x u2.</b> + 160,- <b>2x ZB.</b> + 306,- <b>3x u2.</b> + 120,- <b>2x FSAL 2</b> + 1324,- <b>Z.</b> + 100,- <b>FSK 2.</b> + 783,-		opcje <b>MFTK 20</b> + 187,- <b>2x u2.</b> + 80,- <b>2x ZB.</b> + 306,- <b>3x u2.</b> + 120,- <b>2x FSAL 36</b> + 1550,- <b>Z.</b> + 100,- <b>FSK 2.</b> + 783,-		opcje <b>MFBL 20</b> + 395,- <b>2x u2.</b> + 80,- <b>2x ZB.</b> + 306,- <b>3x u2.</b> + 120,- <b>2x FSAL 36</b> + 1550,- <b>Z.</b> + 100,- <b>FSK 2.</b> + 783,-	
	opcje <b>MFTK 20</b> + 187,- <b>4x u2.</b> + 160,- <b>2x ZB.</b> + 306,- <b>3x u2.</b> + 120,- <b>2x FSAL 2</b> + 1324,- <b>Z.</b> + 100,- <b>FSK 2.</b> + 783,-		opcje <b>MFBL 20</b> + 395,- <b>4x u2.</b> + 160,- <b>2x ZB.</b> + 306,- <b>3x u2.</b> + 120,- <b>2x FSAL 2</b> + 1324,- <b>Z.</b> + 100,- <b>FSK 2.</b> + 783,-		opcje <b>MFTK 20</b> + 187,- <b>2x u2.</b> + 80,- <b>2x ZB.</b> + 306,- <b>3x u2.</b> + 120,- <b>2x FSAL 36</b> + 1550,- <b>Z.</b> + 100,- <b>FSK 2.</b> + 783,-		opcje <b>MFBL 20</b> + 395,- <b>2x u2.</b> + 80,- <b>2x ZB.</b> + 306,- <b>3x u2.</b> + 120,- <b>2x FSAL 36</b> + 1550,- <b>Z.</b> + 100,- <b>FSK 2.</b> + 783,-	
długość 200,0m	<b>MF Z15 B</b> MFB 2090 B MFKP 13 MF 2162 200 / 90 / 75 [270] <b>II. 9461,-</b> <b>III. 10408,-</b>		<b>MF Z15</b> MFB 2090 MFKP 13 MF 2162 200 / 90 / 75 [295] <b>II. 11364,-</b> <b>III. 12501,-</b>		<b>MF Z18 BZ</b> MFB 2090 BZ MFKP 13 MF 31631 200 / 90 / 75 [317] <b>II. 10355,-</b> <b>III. 11391,-</b>		<b>MF Z18 Z</b> MFB 2090 Z MFKP 13 MF 31631 200 / 90 / 75 [319] <b>II. 12487,-</b> <b>III. 13736,-</b>	
	opcje <b>MFTK 20</b> + 187,- <b>4x u2.</b> + 160,- <b>2x ZB.</b> + 306,- <b>3x u2.</b> + 120,- <b>2x FSAL 2</b> + 1324,- <b>Z.</b> + 100,- <b>FSK 2.</b> + 783,-		opcje <b>MFBL 20</b> + 395,- <b>4x u2.</b> + 160,- <b>2x ZB.</b> + 306,- <b>3x u2.</b> + 120,- <b>2x FSAL 2</b> + 1324,- <b>Z.</b> + 100,- <b>FSK 2.</b> + 783,-		opcje <b>MFTK 20</b> + 187,- <b>2x u2.</b> + 80,- <b>2x ZB.</b> + 306,- <b>3x u2.</b> + 120,- <b>2x FSAL 36</b> + 1550,- <b>Z.</b> + 100,- <b>FSK 2.</b> + 783,-		opcje <b>MFBL 20</b> + 395,- <b>2x u2.</b> + 80,- <b>2x ZB.</b> + 306,- <b>3x u2.</b> + 120,- <b>2x FSAL 36</b> + 1550,- <b>Z.</b> + 100,- <b>FSK 2.</b> + 783,-	
	opcje <b>MFTK 20</b> + 187,- <b>4x u2.</b> + 160,- <b>2x ZB.</b> + 306,- <b>3x u2.</b> + 120,- <b>2x FSAL 2</b> + 1324,- <b>Z.</b> + 100,- <b>FSK 2.</b> + 783,-		opcje <b>MFBL 20</b> + 395,- <b>4x u2.</b> + 160,- <b>2x ZB.</b> + 306,- <b>3x u2.</b> + 120,- <b>2x FSAL 2</b> + 1324,- <b>Z.</b> + 100,- <b>FSK 2.</b> + 783,-		opcje <b>MFTK 20</b> + 187,- <b>2x u2.</b> + 80,- <b>2x ZB.</b> + 306,- <b>3x u2.</b> + 120,- <b>2x FSAL 36</b> + 1550,- <b>Z.</b> + 100,- <b>FSK 2.</b> + 783,-		opcje <b>MFBL 20</b> + 395,- <b>2x u2.</b> + 80,- <b>2x ZB.</b> + 306,- <b>3x u2.</b> + 120,- <b>2x FSAL 36</b> + 1550,- <b>Z.</b> + 100,- <b>FSK 2.</b> + 783,-	
	opcje <b>MFTK 20</b> + 187,- <b>4x u2.</b> + 160,- <b>2x ZB.</b> + 306,- <b>3x u2.</b> + 120,- <b>2x FSAL 2</b> + 1324,- <b>Z.</b> + 100,- <b>FSK 2.</b> + 783,-		opcje <b>MFBL 20</b> + 395,- <b>4x u2.</b> + 160,- <b>2x ZB.</b> + 306,- <b>3x u2.</b> + 120,- <b>2x FSAL 2</b> + 1324,- <b>Z.</b> + 100,- <b>FSK 2.</b> + 783,-		opcje <b>MFTK 20</b> + 187,- <b>2x u2.</b> + 80,- <b>2x ZB.</b> + 306,- <b>3x u2.</b> + 120,- <b>2x FSAL 36</b> + 1550,- <b>Z.</b> + 100,- <b>FSK 2.</b> + 783,-		opcje <b>MFBL 20</b> + 395,- <b>2x u2.</b> + 80,- <b>2x ZB.</b> + 306,- <b>3x u2.</b> + 120,- <b>2x FSAL 36</b> + 1550,- <b>Z.</b> + 100,- <b>FSK 2.</b> + 783,-	
wysokość szafki 75,2m				wysokość szafki 110,4m				

# Biurka z komodami i z szafami

## MFB + MFKB + MF



MF Z19		MF Z19 Z		MF Z22		MF Z22 Z	
MFB 1691	MFKB 171	MFB 1691 Z	MFKB 171	MFB 1691	MFKB 171	MFB 1691 Z	MFKB 171
MF 2162		MF 2162		MF 31631		MF 31631	
152,8 / 164,4 / 75 [382]		152,8 / 164,4 / 75 [384]		152,8 / 164,4 / 75 [429]		152,8 / 164,4 / 75 [431]	
II. 11435,- III. 12578,-		II. 11730,- III. 12903,-		II. 12099,- III. 13309,-		II. 12394,- III. 13633,-	
opcje		opcje		opcje		opcje	
MFB 16 + 355,-	4x u2. + 160,-	MFB 16 + 355,-	4x u2. + 160,-	MFB 16 + 355,-	2x u2. + 80,-	MFB 16 + 355,-	2x u2. + 80,-
MFBS 16 + 1533,-	2x ZB. + 306,-	MFBS 16 + 1533,-	2x ZB. + 306,-	MFBS 16 + 1533,-	2x ZB. + 306,-	MFBS 16 + 1533,-	2x ZB. + 306,-
5x U2. + 200,-	2x FSAL 2 + 1324,-	5x U2. + 200,-	2x FSAL 2 + 1324,-	5x U2. + 200,-	2x FSAL 36 + 1550,-	5x U2. + 200,-	2x FSAL 36 + 1550,-
3x Z. + 300,-		3x Z. + 300,-		3x Z. + 300,-		3x Z. + 300,-	
FSK 1 + 991,-		FSK 1 + 991,-		FSK 1 + 991,-		FSK 1 + 991,-	
FSK 2 + 783,-		FSK 2 + 783,-		FSK 2 + 783,-		FSK 2 + 783,-	
MF Z20		MF Z20 Z		MF Z23		MF Z23 Z	
MFB 1891	MFKB 171	MFB 1891 Z	MFKB 171	MFB 1891	MFKB 171	MFB 1891 Z	MFKB 171
MF 2162		MF 2162		MF 31631		MF 31631	
172,8 / 164,4 / 75 [387]		172,8 / 164,4 / 75 [389]		172,8 / 164,4 / 75 [434]		172,8 / 164,4 / 75 [436]	
II. 11588,- III. 12714,-		II. 11850,- III. 13035,-		II. 12222,- III. 13444,-		II. 12514,- III. 13765,-	
opcje		opcje		opcje		opcje	
MFB 18 + 375,-	4x u2. + 160,-	MFB 18 + 375,-	4x u2. + 160,-	MFB 18 + 375,-	2x u2. + 80,-	MFB 18 + 375,-	2x u2. + 80,-
MFBS 18 + 1598,-	2x ZB. + 306,-	MFBS 18 + 1598,-	2x ZB. + 306,-	MFBS 18 + 1598,-	2x ZB. + 306,-	MFBS 18 + 1598,-	2x ZB. + 306,-
5x U2. + 200,-	2x FSAL 2 + 1324,-	5x U2. + 200,-	2x FSAL 2 + 1324,-	5x U2. + 200,-	2x FSAL 36 + 1550,-	5x U2. + 200,-	2x FSAL 36 + 1550,-
3x Z. + 300,-		3x Z. + 300,-		3x Z. + 300,-		3x Z. + 300,-	
FSK 1 + 991,-		FSK 1 + 991,-		FSK 1 + 991,-		FSK 1 + 991,-	
FSK 2 + 783,-		FSK 2 + 783,-		FSK 2 + 783,-		FSK 2 + 783,-	
MF Z21		MF Z21 Z		MF Z24		MF Z24 Z	
MFB 2091	MFKB 171	MFB 2091	MFKB 171	MFB 2091	MFKB 171	MFB 2091 Z	MFKB 171
MF 2162		MF 2162		MF 31631		MF 31631	
192,8 / 164,4 / 75 [392]		192,8 / 164,4 / 75 [394]		192,8 / 164,4 / 75 [439]		192,8 / 164,4 / 75 [441]	
II. 11900,- III. 13090,-		II. 12200,- III. 13420,-		II. 12564,- III. 13820,-		II. 12864,- III. 14150,-	
opcje		opcje		opcje		opcje	
MFB 20 + 395,-	4x u2. + 160,-	MFB 20 + 395,-	4x u2. + 160,-	MFB 20 + 395,-	2x u2. + 80,-	MFB 20 + 395,-	2x u2. + 80,-
MFBS 20 + 1659,-	2x ZB. + 306,-	MFBS 20 + 1659,-	2x ZB. + 306,-	MFBS 20 + 1659,-	2x ZB. + 306,-	MFBS 20 + 1659,-	2x ZB. + 306,-
5x U2. + 200,-	2x FSAL 2 + 1324,-	5x U2. + 200,-	2x FSAL 2 + 1324,-	5x U2. + 200,-	2x FSAL 36 + 1550,-	5x U2. + 200,-	2x FSAL 36 + 1550,-
3x Z. + 300,-		3x Z. + 300,-		3x Z. + 300,-		3x Z. + 300,-	
FSK 1 + 991,-		FSK 1 + 991,-		FSK 1 + 991,-		FSK 1 + 991,-	
FSK 2 + 783,-		FSK 2 + 783,-		FSK 2 + 783,-		FSK 2 + 783,-	

wysokość szafka 75,2cm

wysokość szafka 110,4cm

produkty powiązane



25

biurka



27

przystawki



29

kontenerki



29

komody



31

stoly



33

szafy

M